

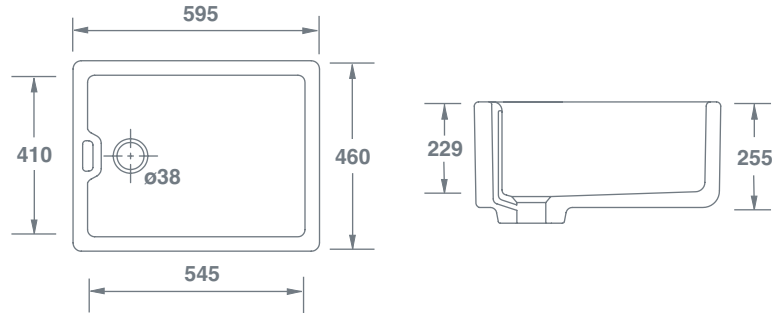





# Pendle



		Dimensions / Abmessungen / Dimensions Dimensiones / Dimensioni					
 <b>Pendle White</b> Weiß / Blanc / Blanco / Bianco	SCPE595WH	(mm)	595	460	255	38	35
 <b>Pendle Biscuit</b> Biskuit / Biscuit / Beige / Biscotto	SCPE595PN	(mm)	595	460	255	38	35
 <b>Pendle Matt Grey</b> Mattgrau / Gris mat / Gris mate / Grigio opaco	SCPE595MG	(mm)	595	460	255	38	35
 <b>Pendle Matt Black</b> Matt Schwarz / Noir mat / Negro mate / Nero opaco	SCPE595MB	(mm)	595	460	255	38	35



**PLEASE NOTE**, our sink dimensions can vary by a plus or minus of 2%, as they are hand-made and shrink during firing.

**BITTE BEACHTEN SIE BITTE**, dass die Abmessungen unserer Spülbecken um ca. 2% variieren können, da sie handgefertigt sind und beim Brennen schrumpfen.

**ATTENTION**, les dimensions de nos éviers peuvent varier de plus ou moins 2%, car ils sont fabriqués à la main et rétrécissent pendant la cuisson.

**TENGA EN CUENTA** que las dimensiones de nuestros fregaderos pueden variar en más o menos un 2%, ya que están hechos a mano y se encogen durante la cocción.

**SI PREGA DI NOTARE** che le dimensioni del nostro lavello possono variare di un più o meno del 2%, in quanto sono fatti a mano e si restringono durante la cottura.

**Features include:** Slim wall single bowl sink with 38mm waste outlet to accommodate slotted waste or a 38mm basket strainer. Weir overflow.

**Funktionen umfassen:** Schlankes, einwandiges Spülbecken mit 38mm Ablauf und Siebkorb. Integrierter Überlauf.

**Caractéristiques:** Évier 1 bac à parois fines. Trou d'évacuation de 38mm adapté aux bannes à panier ou aux vidages avec trop-pleins. Trop-plein type déversoir.

**Características:** Fregadero de 1 cubeta con pared fina. Agujero desagüe central de 38mm compatible con válvulas con cesta o válvulas con rebosadero. Rebosadero tipo aliviadero.

**Le caratteristiche includono:** Lavello a parete sottile a vasca singola con scarico da 38mm per tritarifiuti o un filtro a cestello. Troppopieno a strabocco.