

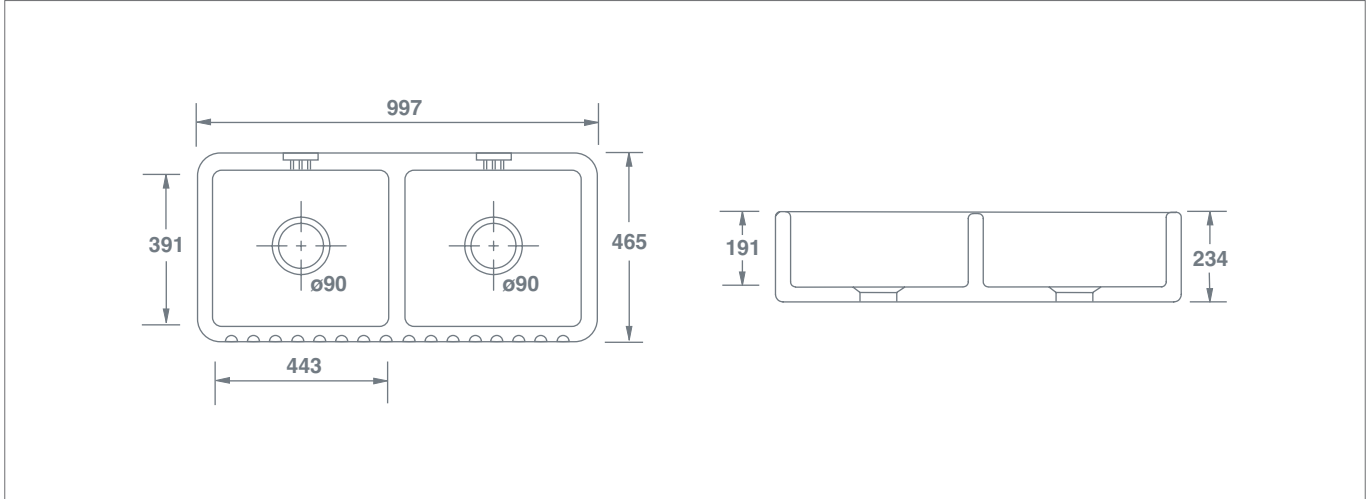





Ribchester 1000



		Dimensions / Abmessungen / Dimensions Dimensiones / Dimensioni						
	Ribchester 1000 White Weiß / Blanc / Blanco / Bianco	SO2400010WH	(mm)	997	465	234	90	76
	Ribchester 1000 Biscuit Biskuit / Biscuit / Beige / Biscotto	SO2400010PN	(mm)	997	465	234	90	76
	Ribchester 1000 Matt Grey Mattgrau / Gris mat / Gris mate / Grigio opaco	SO2400010MG	(mm)	997	465	234	90	76
	Ribchester 1000 Matt Black Matt Schwarz / Noir mat / Negro mate / Nero opaco	SO2400010MB	(mm)	997	465	234	90	76



PLEASE NOTE, our sink dimensions can vary by a plus or minus of 2%, as they are hand-made and shrink during firing.

BITTE BEACHTEN SIE BITTE, dass die Abmessungen unserer Spülbecken um ca. 2% variieren können, da sie handgefertigt sind und beim Brennen schrumpfen.

ATTENTION, les dimensions de nos éviers peuvent varier de plus ou moins 2%, car ils sont fabriqués à la main et rétrécissent pendant la cuisson.

TENGA EN CUENTA que las dimensiones de nuestros fregaderos pueden variar en más o menos un 2%, ya que están hechos a mano y se encogen durante la cocción.

SI PREGA DI NOTARE che le dimensioni del nostro lavello possono variare di un più o meno del 2%, in quanto sono fatti a mano e si restringono durante la cottura.

Features include: Double bowl sink with central dividing wall. Distinctive fluted front. 3 hole overflows. 90mm waste outlets suitable for basket strainers or waste disposers.

Funktionen umfassen: Doppelspülbecken mit zentraler Trennwand. Markant geriffelte Front. 3-Loch-Überläufe. 90mm Ablauf, geeignet für Siebkörbe.

Caractéristiques: Évier 2 bacs avec cloison centrale. Façade cannelée. Trop-plein à 3 trous. Trou d'évacuation de 90mm adapté aux bondes à panier.

Características: Fregadero de 2 cubetas con pared divisoria central. Frontal acanalado. Rebosadero de 3 agujeros. Agujero desagüe de 90mm compatible con válvulas con cesta.

Le caratteristiche includono: Lavello a doppia vasca con parete divisoria centrale. Distintivo frontale scanalato troppopieno a tre fori. Bocchette di scarico da 90mm adatte per filtri a cestello o per tritarifiuti.